

DETAIL ON 'A'
SCALE 1 : 2.5

PARTS LIST				
ITEM	QTY	PART NUMBER	STOCK NUMBER	DESCRIPTION
1	1	DBB295 right	EPG507	ERW PRE GALV 50.8 MM OD X 1.5 MM WALL X 2950 MM LONG

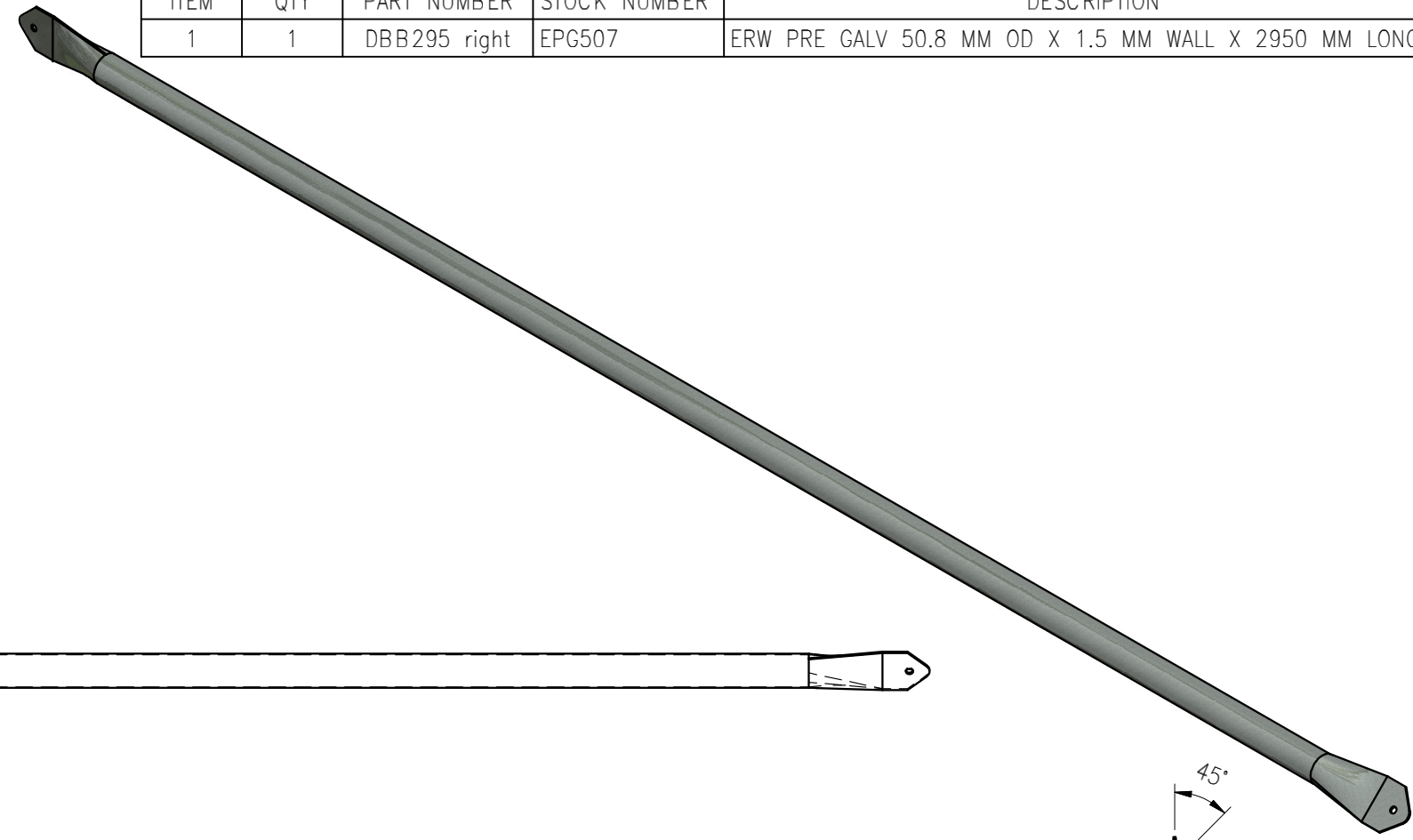

RIGHT HAND SHOWN

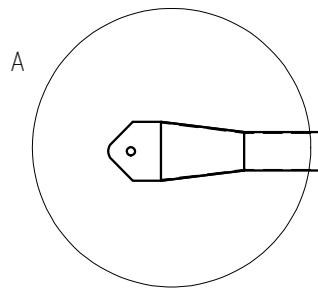
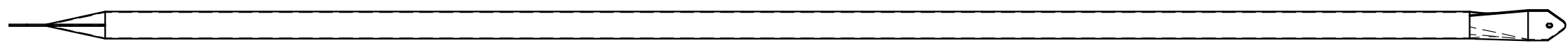

LEFT HAND SHOWN

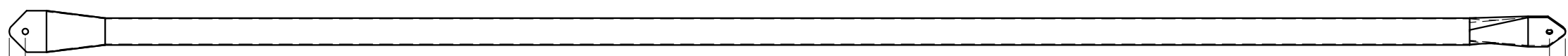
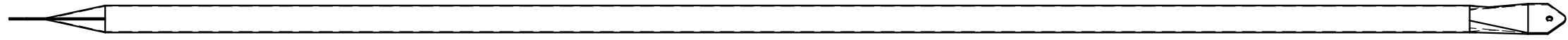

2860 HOLE TO HOLE

2920

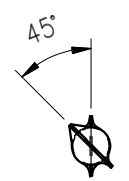
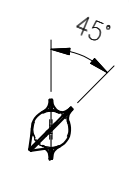

GENERAL TOLERANCES ONLY TO MACHINED SURFACE			
DIMENSIONS SHOWN	TOLERANCE	DIMENSIONS SHOWN	TOLERANCE
X	± 1.00mm	X,XX	± 0.25mm
X.X	± 0.50mm	X,XXX	± 0.13mm

THE FOLLOWING NOTES APPLY TO ALL MANUFACTURING DRAWINGS & ANY DEVIATION FROM THESE NOTES MAY RESULT IN THE MANUFACTURED ITEM(S) BEING REJECTED

1. MANUFACTURER IS TO ENSURE THAT ANY FABRICATIONS ARE PRODUCED TRUE & SQUARE TO GOOD ENGINEERING PRACTICE - PRIOR TO ANY MACHINING

2. ALL FABRICATION DIMENSIONS, I.E. UN-MACHINED MATERIAL SIZES ARE TO BE WITHIN A LIMIT OF 2.5mm (PRIOR TO M/C). THIS IS NOT AN ACCUMULATIVE TOLERANCE AND ANY OVERALL DIMENSIONS ARE TO BE WITHIN ±3.00mm

3. ALL DIMENSIONS TO MACHINED SURFACES, HOLE CENTRES & SLOTS ETC ARE TO BE WITHIN LIMITS SHOWN IN GENERAL TOLERANCE BOX, U.O.S.

4. ALL HOLES & SLOTS ARE TO BE MACHINED TO LIMITS SHOWN IN GENERAL TOLERANCE BOX, TO BE SQUARE & PARALLEL TO DATUM MACHINED FACE

5. ALL MACHINED FACES ARE TO BE SQUARE TO WITHIN ±0.25° U.O.S.

6. ALL MACHINED FACES ARE TO BE PARALLEL TO WITHIN ±0.025mm U.O.S.

7. ALL BORES & DIAMETERS ARE TO BE CONCENTRIC TO WITHIN ±0.015mm U.O.S.

THIS DRAWING AND THE INFORMATION CONTAINED THEREON IS THE EXCLUSIVE PROPERTY OF NP STRUCTURES LTD. IT MUST NOT BE COPIED, OR USED WITHOUT THE PRIOR WRITTEN CONSENT OF NP STRUCTURES, EXCEPT WHERE SUCH INFORMATION WAS SUPPLIED TO NP STRUCTURES LTD BY THE CLIENT TO WHOM THE DRAWING IS SUPPLIED.

northern polytunnels
built to last

MILL GREEN, WATERSIDE ROAD, COLNE, LANCASHIRE. BB8 0TA
tel: +44 (0) 1282 873120 fax: +44 (0) 1282 871733
email: info@npstructures.co.uk web: www.npstructures.co.uk

REV	DESCRIPTION	BY	DATE
A	HOLE TO HOLE CHANGED FROM 2870 TO 2860mm	MJW	04/03/2020

REVISION HISTORY			
DO NOT SCALE IF IN DOUBT ASK	PRODUCT CODE DBB295	DRAWN BY MJW	DRAWING TITLE DIAGONAL BRACE BAR CORNER ANGLED (HANDED PAIR)
THIS DRAWING HAS BEEN DRAWN TO THIRD ANGLE PROJECTION	FIRST USED	DATE DRAWN 07/03/2018	IDENTIFICATION NUMBER DBB295
	SIMILAR TO	SCALE @ SIZE 1:10 @ A3	REV A